

# MULTIUSER OFDM-MIMO EFFECT WITH FAIR RESOURCE ALLOCATION IN ACTUAL INDOOR MULTIPATH ENVIRONMENT

*Kentaro Nishimori, Riich Kudo, Yasushi Takatori, Atsushi Ohta, and Shuji Kubota*

NTT Network Innovation Laboratories, NTT Corporation  
1-1 Hikari-no-oka, Yokosuka-shi, Kanagawa, Japan  
nishimori@m.ieice.org

## ABSTRACT

In this paper we evaluate the measured Multi-user MIMO effect with fair resource allocation by using a MU-MIMO testbed, which can evaluate  $8 \times 8$  MIMO channel in an indoor multipath environment. MU-MIMO systems have attracted attention as a technology for increasing the total system capacity. However, unlike single user MIMO (SU-MIMO) systems, multiple receivers cannot cooperate with each other. Thus, the transmit beamforming method at the access point should be designed to cope with interference among multiple spatial channels. Although several approaches to beamforming have been proposed for MU-MIMO systems depending on the degree of awareness of fairness among multiple mobile stations, we focus on a fair resource allocation approach that evenly assigns transmission time to each terminal in order to support terminal diversity better. Although most papers discuss the MU-MIMO effect based on computer simulations or theoretical analysis, only a few measured results have been presented. In this paper, the numbers of users and antennas at the mobile station suitable for MU-MIMO with fair resource allocation are discussed.

keywords: *Multi-user MIMO, Single-user MIMO, transmit beamforming, Fair resource allocation, indoor multipath environment*

## 1. INTRODUCTION

The growing popularity of mobile phone systems and wireless LANs has driven the demand to achieve broadband wireless transmission within a limited frequency band. Multiple input multiple output (MIMO) systems have attracted much attention because they promise to increase the channel capacity compared to that for the single input single output (SISO) systems [1]- [4].

---

The authors thank Mr. Yoshinobu Makise, Mr. Satoru Tawara, and Mr. Masaaki Ida of NTT Advanced Technology Corporation for their assistance. This work is supported by the Ministry of Internal Affairs and Communications, Japan, under the grant, "Research and development of fundamental technologies for advanced radio frequency spectrum sharing in mobile communication systems."

In important applications such as wireless LAN and cellular systems, MIMO systems likely operate in environments for which a single base station simultaneously communicate with many users. Space Division Multiple Access (SDMA) is a well known technique for improving the channel capacity by creating different antenna patterns for multiple users [5]. Similarly, Multiple MIMO channels can be generated for multiple users by utilizing MIMO and SDMA technologies [6]. Such Multi-User (MU) MIMO systems require development of new techniques through which the total system capacity can be further improved [6]- [8].

In downlink MU-MIMO systems, multiple mobile stations are considered as a virtual large reception array antenna so that a large MIMO effect is expected even when using simple MSs. However, unlike Single User MIMO (SU-MIMO) systems, multiple receivers cannot cooperate with each other. Thus, the transmit beamforming method at the Access Point (AP) should be designed to cope with interference among multiple spatial channels.

There are three approaches to beamforming in MU-MIMO systems depending on the degree of awareness of fairness among multiple MSs: maximizing the total channel capacity approach, guaranteeing the quality of services (QoS) approach, and the fair resource allocation approach [8]. This paper focuses on the third approach, i.e. the fair resource allocation approach, to support terminal diversity better. Although most papers discuss the MU-MIMO effect based on computer simulations or theoretical analysis [9] [10], only a few measured results have been presented [11]. In this paper, we show the measured MU-MIMO effect with fair resource allocation in an indoor multipath environment. The measured results clarify that the MU-MIMO increases not only the total throughput, but also the throughput of each MS.

The rest of this paper is organized as follows. Section 2 outlines the  $8 \times 8$  MU-MIMO testbed and communication flow using Orthogonal Frequency Division Multiplexing (OFDM) signals. Section 3 presents experimental results for the achievable transmission rate of MU-MIMO with fair resource allocation. Particularly in Section 3, we focus on a comparison between MU-MIMO with fair resource allocation and SU-

MIMO using eigenmode transmission when the numbers of MSs and transmit beams are changed.

## 2. HARDWARE CONFIGURATION OF MU-MIMO TESTBED

### 2.1. Hardware configuration

The configuration of the experimental testbed for MU-MIMO-OFDM transmission is shown in Fig. 1. Its main parameters are given in Table 1. The center frequency of this testbed is 4.85 GHz. To evaluate the effect of the number of antennas and users in MU-MIMO channels, we set the numbers of transmitters and receivers to eight. The  $8 \times 8$  MU-MIMO-OFDM transmission can be evaluated using the maximum bandwidth of 100 MHz. Although the MU-MIMO scenario in Fig. 1 represents the case in which the numbers of receive antennas and users are four and two, respectively, various combinations for the numbers of antennas and users can be used. For example, if the number of receive antennas per user is set to two, then we can deal with MU-MIMO transmission for four users. When a single antenna at a MS is assumed, a maximum of eight users can be considered.

At the transmitters, the transmit signals are generated in a personal computer (PC), and uploaded to a digital/analog (D/A) converter as shown in Fig. 1. After the D/A conversion of these signals, frequency conversion is applied and the RF signals at 4.85 GHz are transmitted. At the receivers, these signals are down-converted and A/D conversion is applied. These signals are finally transferred to a PC. For the purpose of evaluating the various transmission control schemes and scheduling algorithms, we perform off-line signal processing in the testbed. Moreover, the Channel State Information (CSI) is transferred over a wired connection and used to determine the transmission weights when we assume transmit beamforming using an actual signal.

As shown in Fig. 1, signal generators are used for the local oscillators to enhance the stability of the frequency converter among the transmitters or receivers. Figure 1 indicates that the carrier and timing synchronization between the transmitters and receivers can be performed independently. Each D/A converter has 128 Mbytes of memory, and signals with various formats can be evaluated. Each A/D converter has 128 Mbytes of memory, and we can continually handle data acquisition for, e.g., six seconds at a maximum of 20 MHz. In this paper, the received data with five seconds was obtained every millisecond.

### 2.2. Communication flow in MU-MIMO testbed

In this subsection, the communication flow using OFDM signals and the transmit signal format in this testbed are described. Table 2 represents the signal parameters that are used in the testbed. At the transmitter, OFDM modulation is employed at each transmit antenna. First, the data sequences are

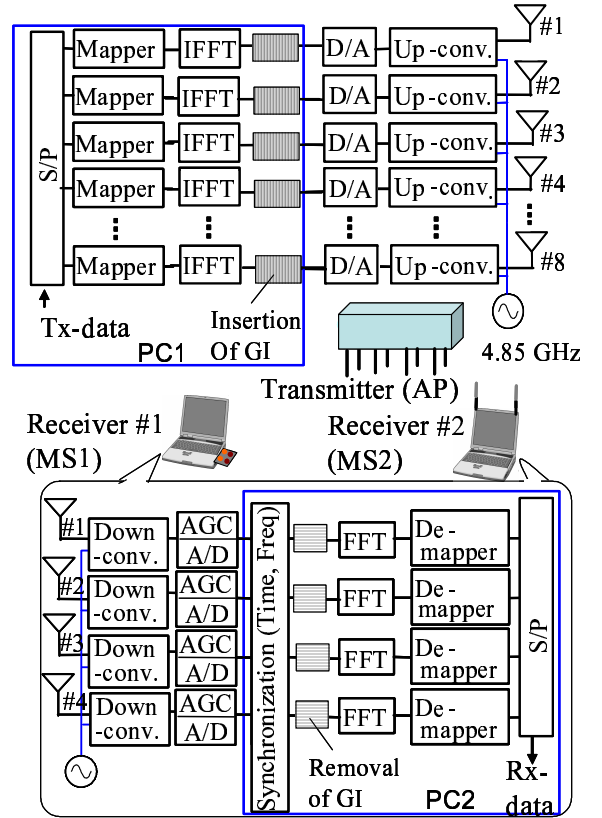

Fig. 1. Block diagram of  $8 \times 8$  MU-MIMO testbed

divided. Then Inverse Fast Fourier transform (IFFT) blocks transform each signal into a time-domain waveform, and guard intervals (GIs) are added to mitigate the effect of multipath fading. Finally, the baseband signals are up-converted to RF signals after D/A conversion and the signals are transmitted from the array antenna.

At the receiver, the received RF signals are down-converted to baseband signals. Next the baseband signals are converted into digital signals using automatic gain control and an A/D converter. Symbol timing detection and automatic frequency control (AFC) are performed from each received short preamble and FFT is applied to the residual signals after the GIs are removed.

The frame format is shown on Fig. 2. This format is based on the IEEE 802.11a standard [13]. As shown in Fig. 2, a long preamble signal is repeatedly transmitted eight times, in order to estimate channel information for each transmit antenna. A short preamble in Fig. 2 is utilized to achieve frame and timing synchronization by calculating the auto correlation of the signals used in the short preamble. The channel matrix is obtained from the long preambles in Fig. 2.

**Table 1.** Hardware Parameters in MU-MIMO Testbed

Number of antennas	8 (Tx), 8 (Rx)
Radio frequency	4.85 GHz
Bandwidth	100 MHz (Max)
Range of AD/DA	14 bits
Transmit power	10 W (Max)
Sensitivity	-20 to -70 dBm

**Table 2.** OFDM Signal Parameters

Number of FFT	64
Number of sub-carriers	48 (Information)+4(Pilot)
Short preamble length	$0.8 \mu \text{ sec} \times 10 = 8 \mu \text{ sec}$
OFDM symbol length	$3.2 \times 2 \mu \text{ sec} + 1.6 \mu \text{ sec(GI)}$

### 2.3. Transmit beamforming method

In this paper, we used the Block Diagonalization Algorithm (BDA) [12] as the transmit beamforming method. In OFDM systems, the BDA is calculated for each subcarrier. For simplicity, we explain the case in which the numbers of users, receive antennas, and the transmit beams for each user are all set to two. First, the CSI is estimated for each user, and the channel matrixes,  $\mathbf{H}_1$  and  $\mathbf{H}_2$ , for MSs 1 and 2 are obtained, respectively. Next, orthogonal matrixes  $\mathbf{H}'_2$  and  $\mathbf{H}'_1$  for Users 1 and 2 are calculated, respectively, so that crosstalk is not generated between the users. After this calculation, Singular Value Decomposition (SVD) is applied to matrixes  $\mathbf{H}'_1$  and  $\mathbf{H}'_2$ , respectively. Finally, eigenvectors  $\mathbf{V}'_1$  and  $\mathbf{V}'_2$  are used for the transmit weights of Users 1 and 2, respectively. At the receiver sites (Users 1 and 2), only the Minimum Mean Square Error (MMSE) [4] is employed, since the orthogonalization between MSs 1 and 2 can be achieved on the transmitter site.

## 3. EFFECT OF MU-MIMO WITH FAIR RESOURCE ALLOCATION

### 3.1. Measurement environment

To evaluate the achievable transmission rate of MU-MIMO with fair resource allocation, channel responses between the

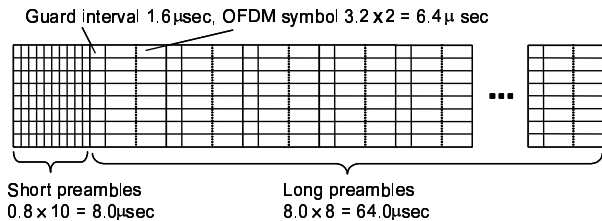
**Fig. 2.** Frame format of transmit signal**Table 3.** Combinations of Number of Beams and MSs

Number of MSs (antennas at MS)	Number of beams per MS
2 (4)	3
2 (4)	4
4 (2)	1
4 (2)	2
8 (1)	1

transmitters and receivers of the MU-MIMO testbed were measured throughout a room. The measurement environment is the  $40 \times 26 \times 3$  m room shown in Fig. 3. There are 60 measurement locations and channel responses are recorded for more than three positions at each location. In this experiment, we use an eight element circular array with the element spacing of 1.0 and a four element linear array with the element spacing of 0.5 as the transmit and receive antennas, respectively. The transmit antenna array at the AP is established on a 2.5 m pole in Fig. 3. The receive antenna array representing the MS is attached to a laptop computer on a desk (0.7 m) and the stars in Fig. 3 indicate the measurement locations. The partitions in the room are constructed of metal and the heights of Partitions 1 and 2 are 1.9 m and 1.2 m, respectively. The total transmit power is 6 dBm. The measured average SNRs are from 8.6 dB to 29.7 dB throughout the room. We also evaluate the eigenmode transmission [14]- [15] as the SU-MIMO scenario using  $8 \times 1$ ,  $8 \times 2$ , and  $8 \times 4$  eigenmode MIMO transmissions [16], respectively. When considering two users in SU-MIMO transmission, we assume that Time Division Multiple Access (TDMA) is applied for each user in the SU-MIMO scheme.

We focus on the comparison between MU-MIMO and SU-MIMO when the numbers of MSs and transmit beams for the MS are changed, in order to understand which users and beams are suitable for MU-MIMO transmission with the fair resource allocation. Table 3 shows the combinations of the number of transmit beams and MSs. We assume that the total number of transmit beams is eight. In other words, there is the following relationship in our evaluation.

$$(\text{Number of MSs}) \times (\text{Number of antennas at MS}) = 8 \quad (1)$$

The number of MSs is two, four or eight, and the number of antennas at the MS is four, two, or one, respectively. The number of antenna branches at the AP is fixed at eight. The number of beams is shown in Table 3. The MS combinations are randomly selected.

### 3.2. Comparison of achievable transmission rate between MU-MIMO and SU-MIMO

Figures 4 and 5 show the achievable data rate when a two-user (four-element antennas at each MS) scenario is considered. The total achievable data rate and the difference in the number of beams for each MS are compared in Figs. 4(a) and

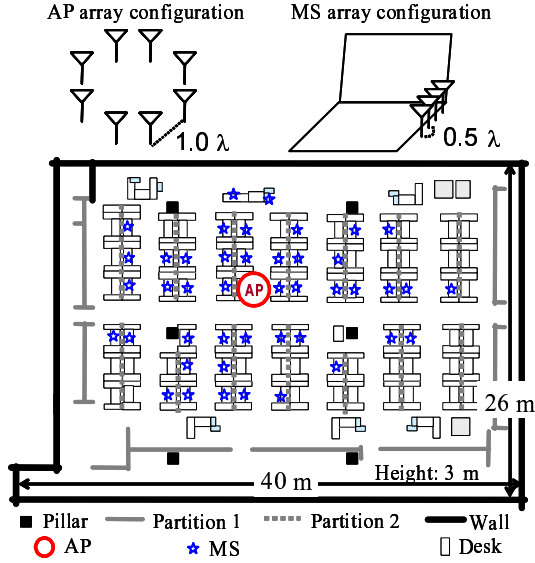

Fig. 3. Measurement environment

5(a). Figures 4(a) and 5(a) show that MU-MIMO with fair resource allocation outperforms SU-MIMO and the degree of improvement increases in a high data rate region. When we compare the results between Figs. 4(a) and 5(b), we find that the improvement by MU-MIMO with three beams is higher than that with four beams. When four beams per MS are used in the MU-MIMO scenario, there is a chance to increase the total channel capacity. However, the minimum eigenvalue becomes very small because a total of eight beams are used in the MU-MIMO scenario. In [16], we showed that using fewer beams than the number of received antennas is effective from the viewpoint of the diversity effect when transmit beamforming is considered. When considering three beams in the MU-MIMO scenario, the total achievable rate can be improved compared to four beams in MU-MIMO. Similarly, when SU-MIMO with transmit beamforming is considered, the diversity effect is accomplished by creating a *single*  $8 \times 3$  or  $8 \times 4$  MIMO channel.

Figures 4(b) and 5(b) show the achievable data rate for each MS when three and four transmit beams per MS are considered, respectively. As we described in Section 3.1, we assume that TDMA is applied for each user in the SU-MIMO scheme. Thus, the achievable bit rate for each user in the SU-MIMO scheme in Figs. 4(b) or 5(b) becomes half that in Figs. 4(a) or 5(a). We find that MU-MIMO increases the achievable data rate of each MS the most when four transmit beams are considered. Figure 4(b) shows that the achievable rate of the MU-MIMO scheme always outperforms that of the SU-MIMO and the improvement increases in a high data rate region. Thus, we confirm that using fewer beams than the number of received antennas is effective from the viewpoint of the diversity effect when the number of antennas at

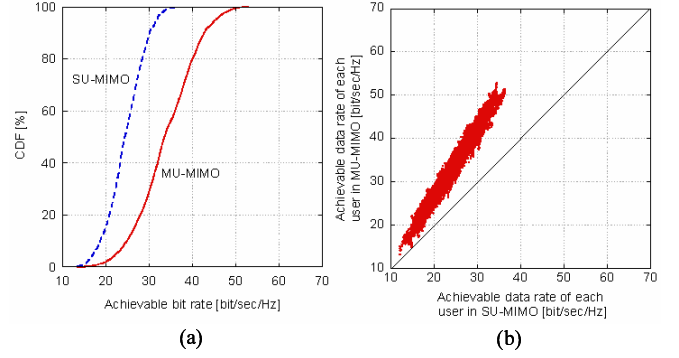

Fig. 4. Achievable data rate when 2MSs and 3beams for each MS are considered (a) Total achievable data rate (b) Achievable data rate of each user

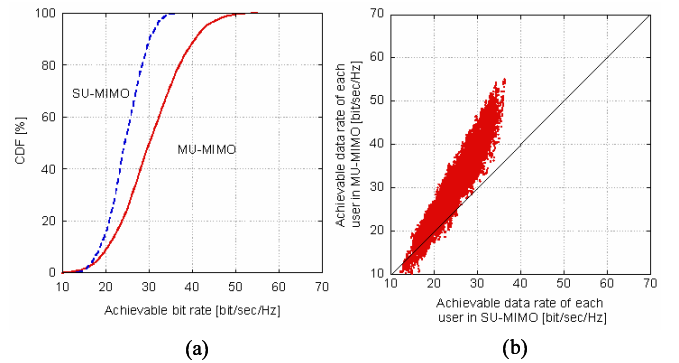
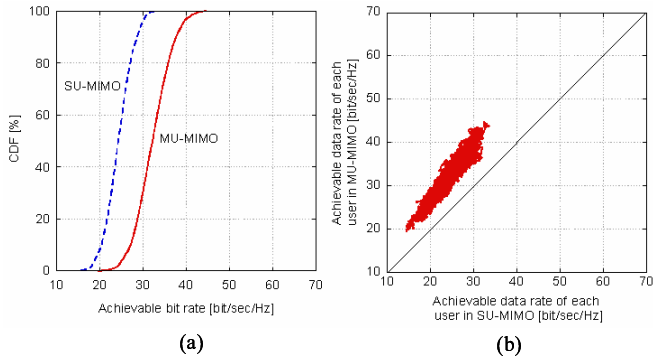

Fig. 5. Achievable data rate when 2MSs and 4beams for each MS are considered (a) Total achievable data rate (b) Achievable data rate of each user

a MS is four. Figure 5(b) shows that the achievable data rate of MU-MIMO varies by more than 10 bit/sec/Hz when that of SU-MIMO becomes 15 bit/sec/Hz. Thus, we confirm that using fewer beams than the number of received antennas is effective when the number of antennas at a MS is four.

Figure 6 and 7 show the achievable data rate when a four user (two-element antennas at each MS) scenario is considered. Figures 6(a) and 7(a) show the total achievable rate, and Figs. 6(b) and 7(b) show the achievable rate of each user. Since TDMA is assumed for each user in the SU-MIMO scheme, the achievable bit rate for each user in Figs. 6(b) or 7(b) becomes 1/4 of that in Fig. 6(a) or 7(a). These results show that MU-MIMO with fair resource allocation always increases not only the total throughput, but also the throughput of each user. When the scenario with four users is considered, the total achievable bit rate is greatly improved by increasing the number of transmit beams. Thus, we found that increasing the number of transmit beams is effective if the number of beams is less than the number of receive antennas for each MS.



**Fig. 6.** Achievable bit rate when 4MSs and 1beam for each MS are considered (a) Total achievable data rate (b) Achievable data rate of each user

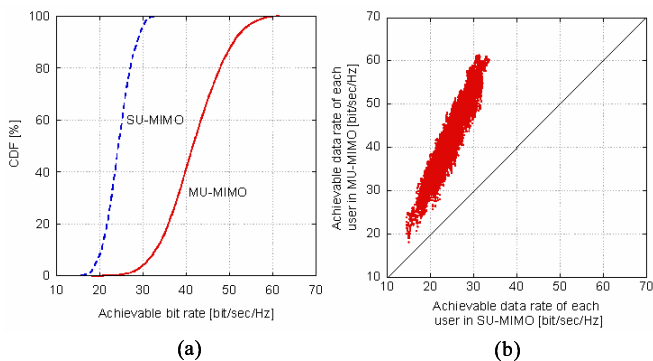
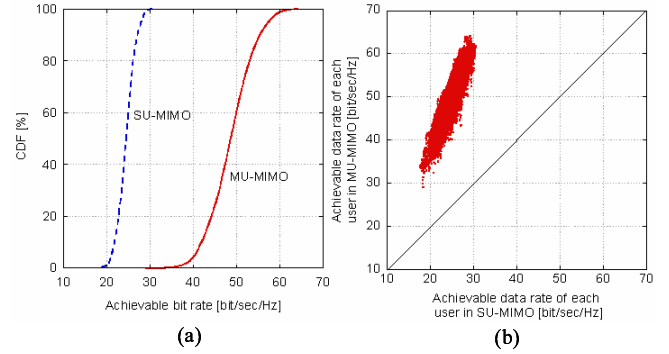

**Fig. 7.** Achievable data rate when 4MSs and 2beams for each MS are considered (a) Total achievable data rate (b) Achievable data rate of each user

Figure 8 shows the achievable data rate when an eight user (one-element antennas at each MS) scenario is considered. Figures 8(a) and 8(b) show the total achievable rate and the achievable rate of each user, respectively. Since TDMA is assumed for each user in the SU-MIMO scheme, the achievable bit rate for each user in Fig. 8(b) becomes 1/8 of that in Fig. 8(a). These results show that MU-MIMO with fair resource allocation always increases not only the total throughput, but also the throughput of each user. Moreover, we confirm that the improvement by applying MU-MIMO with fair resource allocation in Fig. 8 becomes the highest among the combinations of the numbers of beams and MSs given in Table 3.

#### 4. CONCLUSION

In this paper, the MU-MIMO effect with fair resource allocation was evaluated with measured channel responses in a typical indoor office room. The measured results clarified that



**Fig. 8.** Achievable data rate when 8MSs and 1beam for each MS are considered (a) Total achievable data rate (b) Achievable data rate of each user

MU-MIMO with fair resource allocation increases not only the total throughput, but also the throughput of each user. We also confirmed that MU-MIMO with fair resource allocation is the most effective compared to SU-MIMO with eigenvector beamforming when a large number of users (four to eight) with a small number of antennas (one to two) are considered in an indoor environment using an 8x8 MU-MIMO-OFDM testbed. Even if the number of antennas at the MS is four, we clarified that not only the total achievable bit rate, but also the achievable bit rate of each user is always improved compared to that for SU-MIMO by selecting fewer transmit beams at the transmitter than the number of receive antennas.

#### 5. REFERENCES

- [1] G. J. Foschini and M. J. Gans, "On limits of wireless communications in a fading environment when using multiple antennas," *Wireless Personal Commun.*, vol. 6, pp. 311-335, 1998.
- [2] G. L. Stuber, et al., "Broadband MIMO-OFDM wireless communications," *Proceedings of IEEE*, vol. 92, pp. 271-294, Feb. 2004.
- [3] "MIMO implementation aspects," *IEEE Radio and Wireless Conference (RAWCON), Workshop WS2*, Sep. 2004.
- [4] A. Paulraj, R. Nabar, and D. Gore, "Introduction to Space-Time Wireless Communications," Cambridge University Press, 2003.
- [5] R. H. Roy, "Spatial division multiple access technology and its application to wireless communication systems," *Proc. of IEEE VTC 1997*, vol. 2, pp. 730-734, May 1997.
- [6] Q. H. Spencer, C. B. Peel, A. L. Swindlehurst, and M. Haardt, "An introduction to the multi-user MIMO downlink," *IEEE Communications Magazine*, vol. 42, pp. 60 - 67, Oct. 2004.

- [7] G. Caire and S. Shamai, "On the achievable throughput of a multiantenna Gaussian broadcast channel," *IEEE Trans. Inform. Theory*, vol. 49, pp. 1691-1706, July 2003.
- [8] A. J. Tenenbaum and R. S. Adve, "Joint multiuser transmit-receive optimization using linear processing," *IEEE ICC2004*, vol. 1, pp. 588-592, June 2004.
- [9] G. L. Stuber, et al., "Broadband MIMO-OFDM wireless communications," *Proceedings of IEEE*, vol. 92, pp. 271-294, Feb. 2004.
- [10] A. Goldsmith, S. A. Jafar, N. Jindal, S. Vishwanath, "Capacity limits of MIMO channels," *IEEE Journal on JSAC*, vol. 21, pp. 684-702, June 2003.
- [11] K. Nishimori, R. Kudo, Y. Takatori, A. Ohta, and S. Kubota, "Performance evaluation of  $8 \times 8$  Multi-user MIMO-OFDM testbed in an actual indoor environment," *Proc. of IEEE PIMRC2006*, vol.1, pp.1-5, Sept., 2006.
- [12] K. K. Wong, R. D. Murch, and K. B. Letaief, "A joint-channel diagonalization for multiuser MIMO antenna systems," *IEEE Trans. Wireless Commun.*, vol. 2, pp. 773-786, July 2003.
- [13] IEEE802.11.a, "High speed physical layer (PHY) in 5 GHz band," 1999.
- [14] J. B. Andersen, "Array gain and capacity for known random channels with multiple element arrays at both ends," *IEEE J. Sel. Areas Commun.*, vol. 18, No. 11, pp. 2172-2178, Nov. 2000.
- [15] K. Miyashita, T. Nishimura, T. Ohgane, Y. Ogawa, Y. Takatori, and K. Cho, "High data-rate transmission with Eigenbeam Space Division Multiplexing (E-SDM) in a MIMO channel," *Proc. of IEEE VTC2002-Fall*, vol. 3, pp. 1302-1306, 2002.
- [16] R. Kudo, K. Nishimori, Y. Takatori, and K. Tsunekawa, "Experimental Evaluation of Eigenvector Beamforming Method with  $8 \times 4$  MIMO-OFDM Testbed," to appear in *Proc. of IEEE VTC 2006-Spring*, May 2006.