

# HIGH PERFORMANCE RECEIVER FOR RFI MITIGATION IN RADIO ASTRONOMY : APPLICATION AT DECAMETER WAVELENGTHS

*Vincent Clerc<sup>1</sup>, Rodolphe Weber<sup>2</sup>, Laurent Denis<sup>1</sup>, Carlo Rosolen<sup>1</sup>*

1. Observatoire de Paris-Meudon-Nancay, 5, Place Jules Janssen,  
92195 Meudon cedex, France ; e-mail : [Vincent.Clerc@obspm.fr](mailto:Vincent.Clerc@obspm.fr),  
[Laurent.Denis@obs-nancay.fr](mailto:Laurent.Denis@obs-nancay.fr), [Carlo.Rosolen@obspm.fr](mailto:Carlo.Rosolen@obspm.fr)

2. LESI-TRSI, Université d'Orléans BP 6744, 45067, Orléans cédex 2, France

Tel: +33 2 38494562 ; fax: +33238417245 ; e-mail: [weber@lesi.univ-orleans.fr](mailto:weber@lesi.univ-orleans.fr)

## ABSTRACT

As a consequence of the development of telecommunications radio astronomers have to deal with an increasing number of unworkable observations polluted by man-made radio interferences. Thus, a lot of efforts are made to develop specific mitigation techniques. However, it appears that algorithm efficiency is related to the quality of the acquisitions. The first objective of this paper is to show that: 1) receivers must be linear enough to prevent any spread of strong interferences, 2) receivers must reach sufficient spectral resolution to extract radio astronomical information between interference lines. As a result of these two preliminary points, the second objective is to describe the design of our new generation receiver. It is a high dynamic range powerful system for wideband measurements with high spectral resolution and with real time interference excision capabilities.

## 1 INTRODUCTION

The negative impact of radio frequency interferences (RFI) on the quality of radio astronomical observations is a matter of increasing concern for the radio astronomy community. This issue gets worse in the decameter wavelengths where ionospheric effects are sensitive. Figure 1 shows an example of radio emission from Jupiter polluted by man-made RFI.

In this framework, many efforts are currently put into improving RFI mitigation algorithms. Time properties, frequency properties and/or spatial properties are considered in order to find efficient excision processing techniques (see for example [2],[3]).

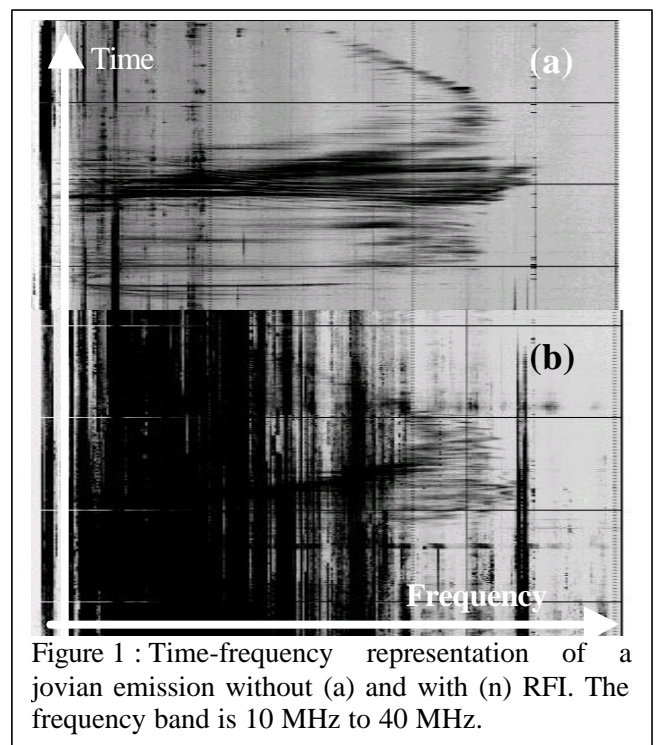

However, it appears that the design of current receivers, which is based on the hypothesis of non-corruptive environment, is not adapted. Indeed, coarse quantization (a few bits) is usually applied to the signal. Unfortunately, when the interference power increases, the non-linearities induced become progressively too important and make spectral estimation completely unusable [1]. That is why new generation of robust receivers must be designed [4].

## 2 HIGH DYNAMIC RANGE

The study of ionospheric effects by two different systems (CNET's survey system and decametric array of Nançay) shows that at night, wide band receivers have to handle an additional variation of the input level due to the disappearance of the D ionospheric layer. Thus, the power spectral density of frequencies under 12 MHz raises while the one of higher frequencies is attenuated. The total dynamic range is around 85 dB (see Figure 2).

Unlike in the telecommunication framework, the presence of strong signals cannot be managed through an automatic gain control. Indeed, given that our signal-of-interest is at the noise level, any attenuation will drastically reduce the sensibility of the receiver.

In conclusion, the receiver line linearity is a critical issue and dynamic range of at least 85 dB must be achieved. In particular, 14 bits analog-to-digital converters (ADC) must be used to digitize the signal.

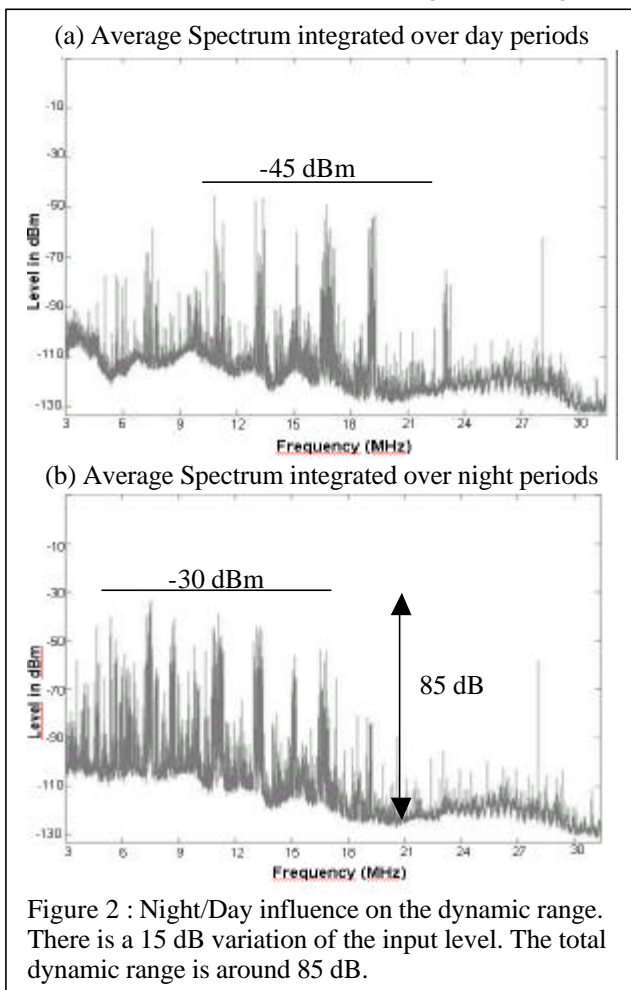

## 3 HIGH FREQUENCY RESOLUTION

In this section, we want to analyse the impact of the frequency resolution on the bandwidth availability. In other words, when your observations are polluted by RFI, is it still possible to find free channels?

This study has been carried out in the decametric band and the results are very interesting. For example, it appears that if you want to recover 90% of your bandwidth, the minimum resolutions are the following:

- for 35-45 MHz, resolution is 6.25 KHz.
- for 25-35 MHz, resolution is 1.6 KHz.
- for 15-25 MHz, resolution is 190 Hz.
- for 5-15 MHz, resolution is 6.25 KHz.

The figure 3 summarizes the different situations. The compromise between resolution and number of free channel can be obtained with this diagram. Accordingly, computational power requirements in digital receivers can be adapted *a priori*.

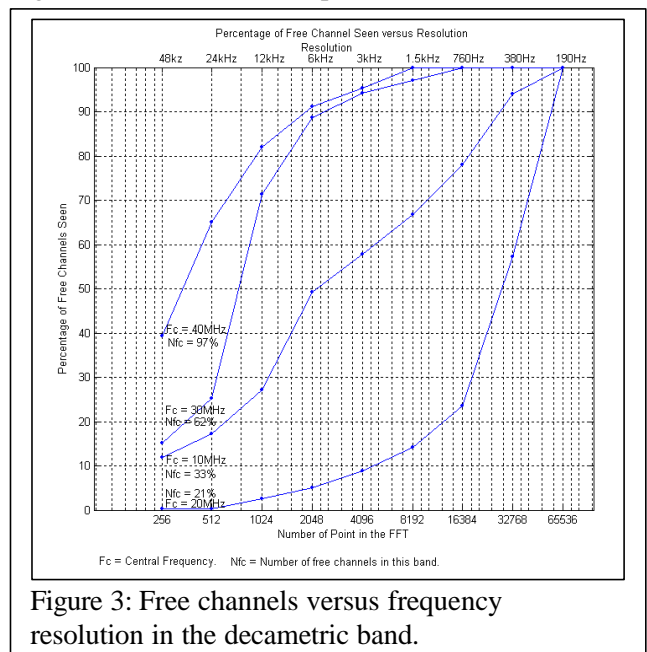

## 4 ROBUST RECEIVER DESCRIPTION

Figure 4 describes the general synoptic of the RB. Height radio telescopes or antennas can be connected to the robust receiver (RR). Optical fibers links are used to send analog signal from antennas to the RR. A non-blocking matrix is used to configure the RR and to share, if needed, its computing power. Then, analog down conversion is applied to shift a 100 MHz

bandwidth from 300 MHz to 70 MHz. A final anti aliasing filter limits the useful bandwidth to 14 MHz. At this point, each signal is digitized with a 14 bits ADC. For two sub bands (14 MHz) the digital signal processing is based on 3 PCI carrier boards (HEPC 9 from HUNT Engineering), each supporting four HERON modules:

- Two modules include 14 bits ADCs associated with respectively Field Programmable Gate Array (FPGA) Virtex II in which the digital down conversion (DDC) is implemented (see the following section).
- Four modules have an FPGA Virtex II running a real time FFT or correlation function.
- The six remaining modules are based on TMS 6203 processor (DSP) providing about 24 GFLOPS of computing power for RFI mitigation.

One powerful industrial PC is used for 3 carrier boards. The four PCs are linked via a fast Ethernet line to a central computer for further data analysis, compression and storage.

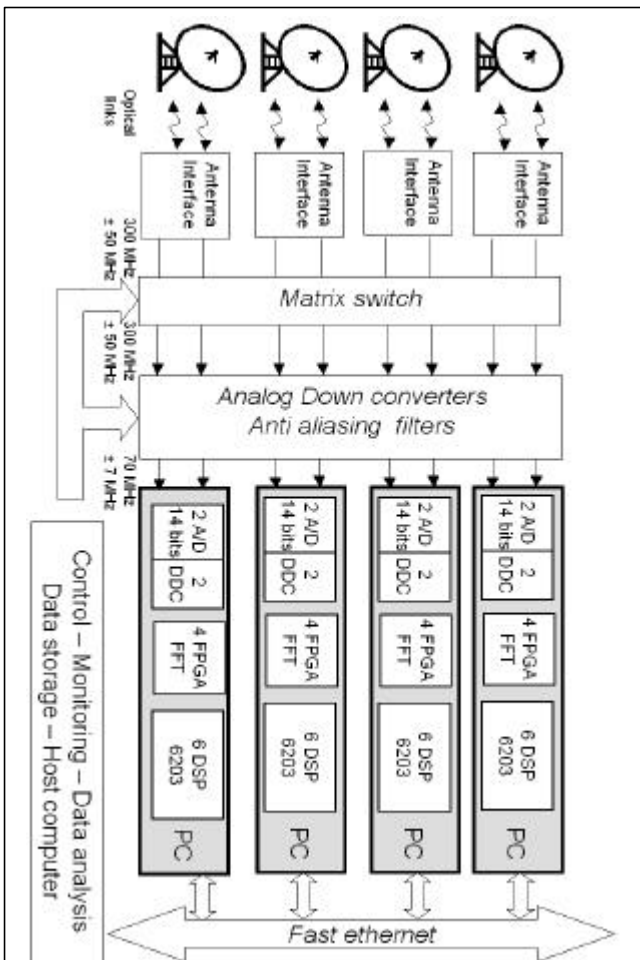

Figure 4 : Synoptic of the robust receiver.

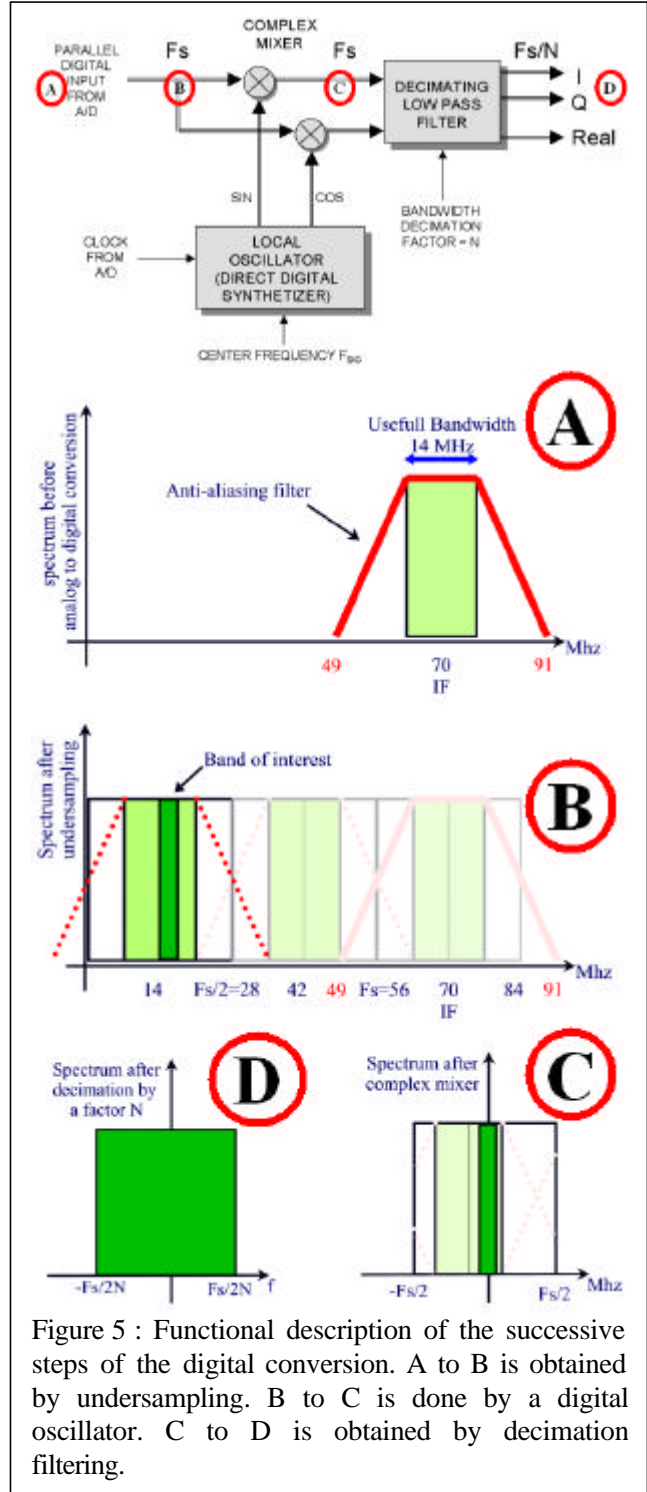

Figure 5 : Functional description of the successive steps of the digital conversion. A to B is obtained by undersampling. B to C is done by a digital oscillator. C to D is obtained by decimation filtering.

### 5 DIGITAL DOWN CONVERSION

The down conversion of the 14 MHz bandwidth at 70 MHz (IF) to base band is achieved digitally in two steps. First, an undersampling is applied with a 56 MHz sampling frequency. Then, a direct digital

synthesizer (DDS) following by successive decimation filters selects the band of interest (see Figure 5).

The decimation filters have been optimized to both minimize the hardware and maximize the frequency selectivity. Thus, five half-band filters have been implemented to process the decimation. A final selective FIR filter with 83 coefficients (17 bits) ends the processing (see Figure 6.a). The final dynamic of this set of filters is 75 dB. The input flow is 56 MHz, the output is 2 x 14 MHz.

In terms of hardware implementation, with a good use of half band properties, polyphase structures and resource sharing, a reduction of required hardware resources is possible (see Figure 6.b). Thus, only 38 multipliers are used for the whole implementation of the DDC. This design has been fitted in a VIRTEX II 1000.

### 6 CONCLUSION

With the proposed design of a robust receiver, it is possible to achieve the high dynamic range and high frequency resolution required for radio astronomical observation in corruptive environments.

It is a 14 bits receiver, fully reconfigurable, with 14 MHz maximum bandwidth. Implementing a real time FFT in the in-board FPGA has made resolution down to 800 Hz possible. Extra computing power is available for real time RFI mitigation algorithms.

### References

- [1] R. Weber, C.Faye, "Coarsely Quantized Spectral Estimation of radio Astronomic Sources in Highly Corruptive Environments", Chapter 7 of *Signal Analysis and Prediction, Prochazka et al., Birkhauser Boston Ed., 1998.*
- [2] P. Ravier, R. Weber, "Décteur robuste de signaux cyclostationnaires : application à la suppression d'interférences en radioastronomie", *18ème Colloque GRETSI, Toulouse, tome 2, pp. 403- 406, Septembre 2001.*
- [3] A. Leshem, A. J. van der Veen, "Radio-astronomical Imaging in Presence of Strong Radio Interference", *IEEE Trans. On Information Theory, vol.46, no. 5, August 2000.*
- [4] C. Rosolen, L. Denis, V. Clerc, R. Weber "New generation of robust receivers at Nançay Radio Astronomy Observatory" *RFI Mitigation Workshop, Bonn, March 28-30 2001*

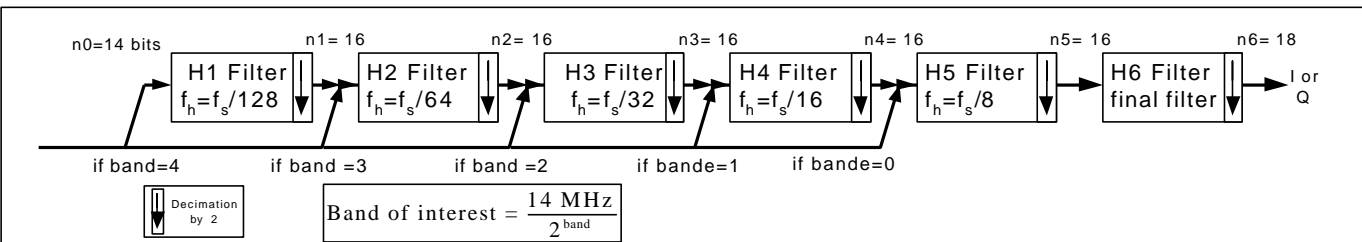

Figure 6.a : Implementation of the decimation filters. H1 to H5 are optimised half-band filters. H6 is FIR filter with 83 coefficients.

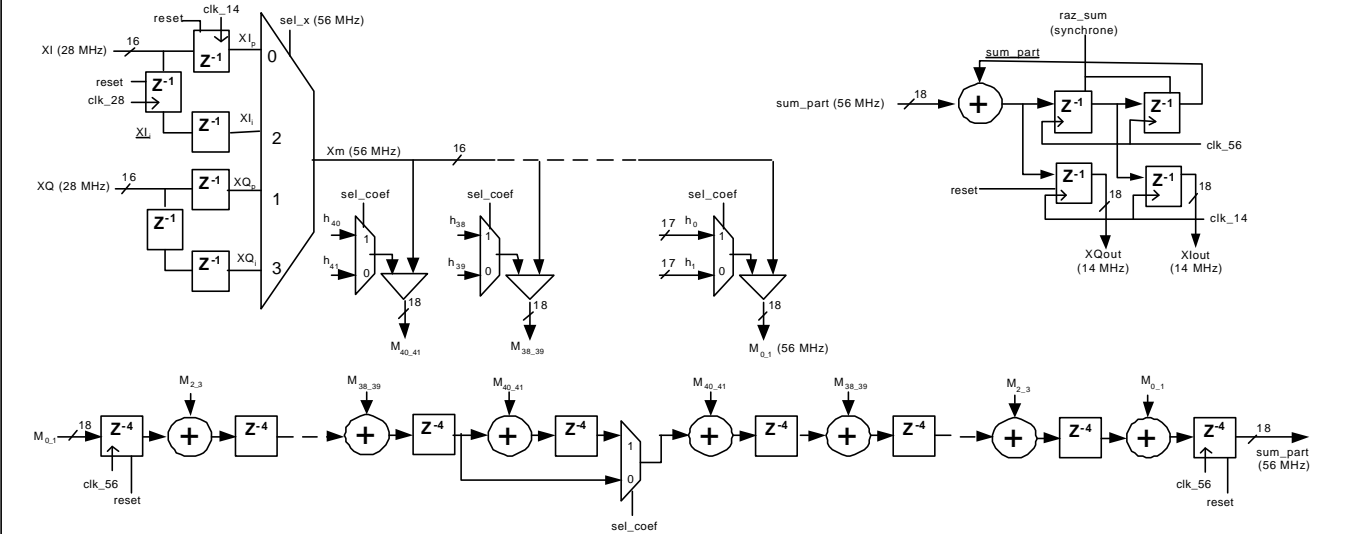

Figure 6.b : Hardware implementation of the H6 filter. The number of multipliers is minimised.