

(a) cluster composition

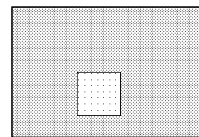

(b) subsampling

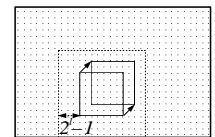

(c) cluster vector detection

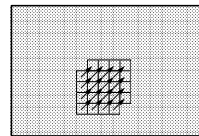

(d) initial vectors

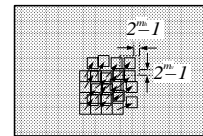

(e) macroblock motion vector

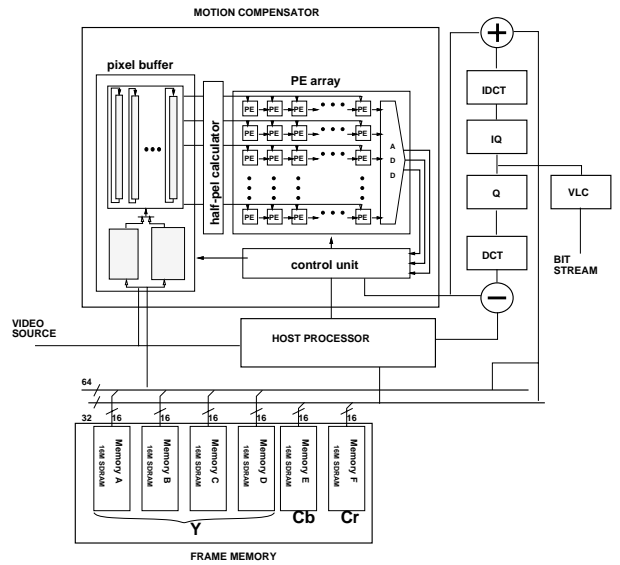
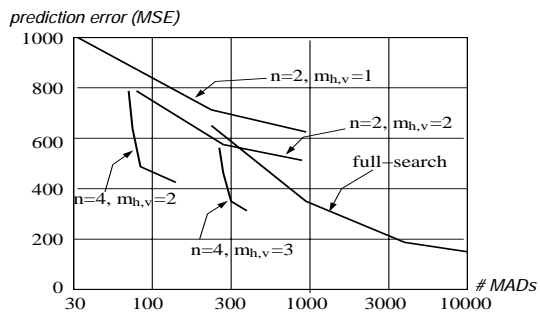
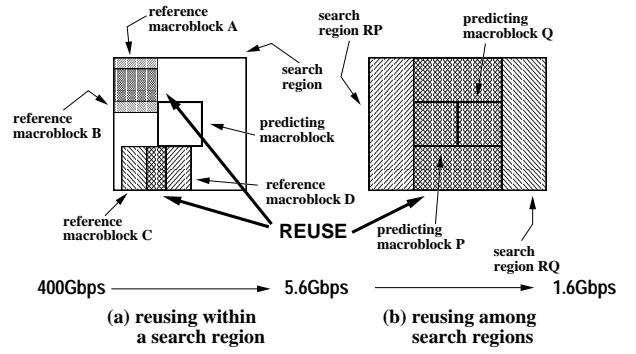

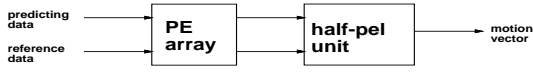

(a) conventional implementation

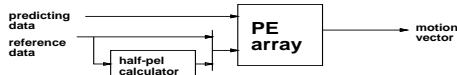

(b) proposed implementation

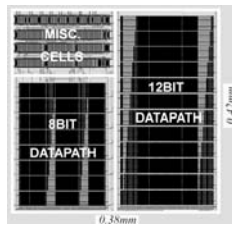
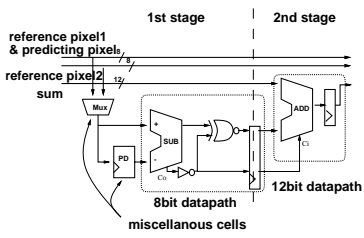
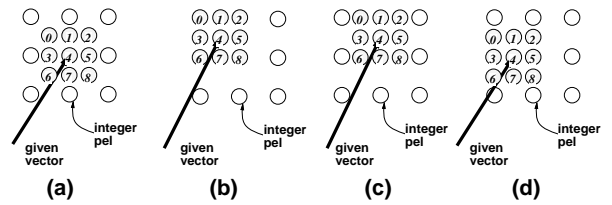
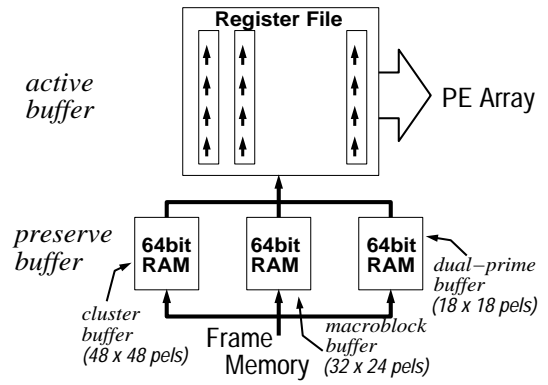

B-picture

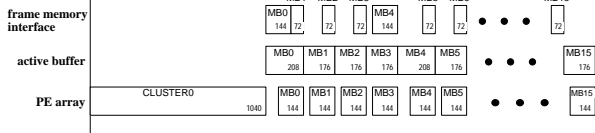

P-picture

